

**START** **1**

Resistor - Weerstand - Résistance - Widerstand - Resistencia - Motstand - Vastus - Resistenze

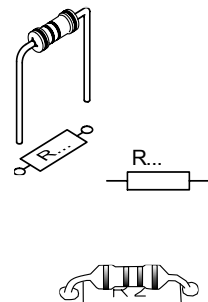

◇ R1, R2 : 330	(Orange, Orange, Brown) - (Oranje, Oranje, Bruin) - (Orange, Orange, Brun) - (Orange, Orange, Braun) - (Oranssi, Oranssi, Ruskea) - (Naranja, Naranja, Marrón) - (Laranja, Laranja, Castanho) - (Aranciato, Aranciato, Marrone)
◇ R3 : 470	(Yellow, Purple, Brown) - (Geel, Paars, Bruin) - (Jaune, Violet, Brun) - (Gelb, Violet, Braun) - (Gul, Lila, Bruin) - (Keltainen, Purppura, Ruskea) - (Amarillo, Morado, Marrón) - (Amarelo, Violeta, Castanho) - (Giallo, Viola, Marrone) - (Gul, Violet, Brun)
◇ R4 : 100K	(Brown, Black, Yellow) - (Bruin, zwart, Geel) - (Brun, noir, Jaune) - (Braun, Schwarz, Gelb) - (Brun, Svart, Gul) - (Ruskea, Musta, Keltainen) - (Marrón, Negro, Amarillo) - (Castanho, Preto, Amarelo) - (Marrone, Nero, Giallo)
◇ R5 : 47K	(Yellow, Purple, Orange) - (Geel, Paars, Oranje) - (Jaune, Violet, Orange) - (Gelb, Violet, Orange) - (Gul, Lila, Oranje) - (Keltainen, Purppura, Oranssi) - (Amarillo, Morado, Naranja) - (Amarelo, Violeta, Laranja) - (Giallo, Viola, Aranciato)
◇ R6, R7 : 4K7	(Yellow, Purple, Red) - (Geel, Paars, Rood) - (Jaune, Violet, Rouge) - (Gelb, Violet, Rot) - (Gul, Lila, Röd) - (Keltainen, Purppura, Punainen) - (Amarillo, Morado, Rojo) - (Amarelo, Violeta, Encarnado) - (Giallo, Viola, Rosso)
◇ R8 : 10K	(Brown, Black, Orange) - (Bruin, Zwart, Oranje) - (Brun, noir, Orange) - (Braun, Schwarz, Orange) - (Brun, Svart, Orange) - (Ruskea, Musta, Oranssi) - (Marrón, Negro, Naranja) - (Castanho, Preto, Laranja) - (Marrone, Nero, Aranciato)
◇ R9 : 10	(Brown, Black, Black) - (Bruin, zwart, zwart) - (Brun, Noir, Noir) - (Braun, Schwarz, Schwarz) - (Brun, Svart, Svart) - (Ruskea, Musta, Musta) - (Marrón, Negro, Negro) - (Castanho, Preto, Preto) - (Marrone, Nero, Nero)
◇ R10 : 1K2	(Brown, Red, Red) - (Bruin, Rood, Rood) - (Brun, Rouge, Rouge) - (Braun, Rot, Rot) - (Brun, Röd, Röd) - (Ruskea, Punainen, Punainen) - (Marrón, Rojo, Rojo) - (Castanho, Encarnado, Encarnado) - (Marrone, Rosso, Rosso)

**9** PCB tabs

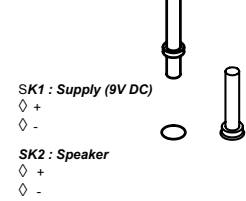

**10** Microphone

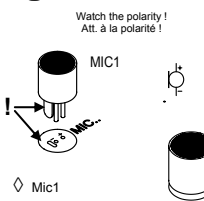

**11** Electrolytic capacitors

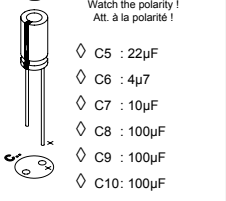

**12** Vertical trimmer

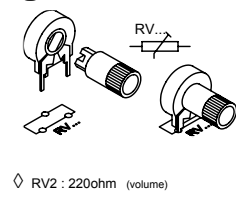

**13** Connection

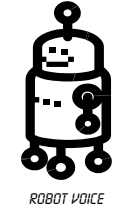
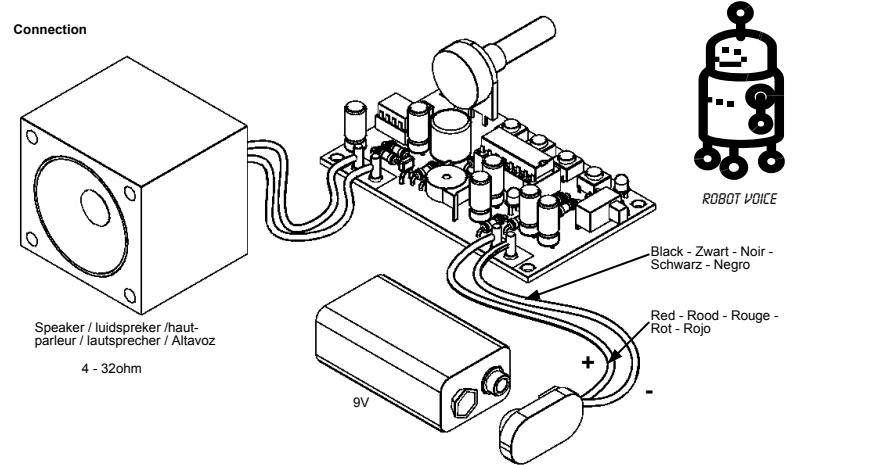

Manual MKT71 - Edition 1 (version1)

**2** Zenerdiode

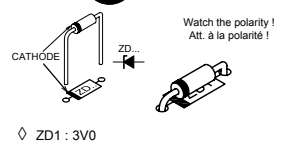

**3** Pushbutton

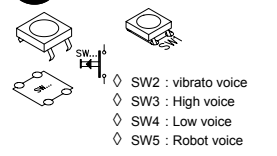

**4** IC-socket

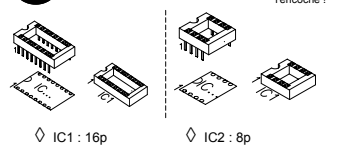

**5** Slide switch

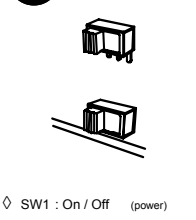

**6** Leds

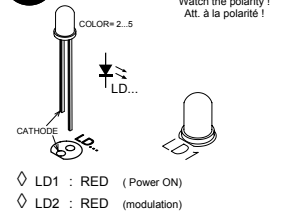

**7** Horizontal trimmer

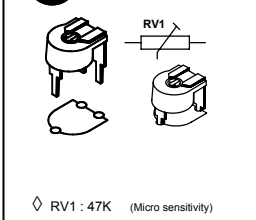

**8** Capacitors

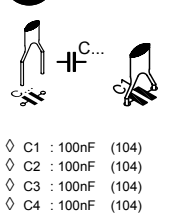

**14** IC

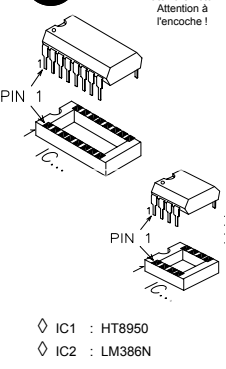

**15** Diagram

