

Total solder points: 239

Difficulty level:

beginner 1  2  3  4  5  advanced

HIGH-Q  
**velleman-kit** 

# 8 Input programmable messageboard with LCD & serial interface

## K8045

### Features :

- ✓ Add an LCD display to any low-tech application and make it look high-tech !
- ✓ Replace up to 9 indicators or lamps by one single backlit LCD.
- ✓ Recall messages simply by pressing a button.
- ✓ Inputs accept dry contacts, open collectors and logic levels.
- ✓ No programming skills required !
- ✓ Store up to 9 sixteen-character messages in non-volatile EEPROM memory.
- ✓ 4 operating modes :
  - 1) Display the status of all inputs simultaneously.
  - 2) Display all active inputs.
  - 3) Display active input with highest priority.
  - 4) Display text messages in a 'tickertape'-fashion.
- ✓ A default message can be entered and is displayed when no inputs are active.
- ✓ Messages can be transferred to the K8045 from any PC or terminal.
- ✓ Free message transfer software and source code for the K8045 is available from [www.velleman.be](http://www.velleman.be)
- ✓ Wireless data transfer between PC/terminal and K8045 is possible with optional RX/TX433 modules.
- ✓ 1 on-board pushbutton available for your application.

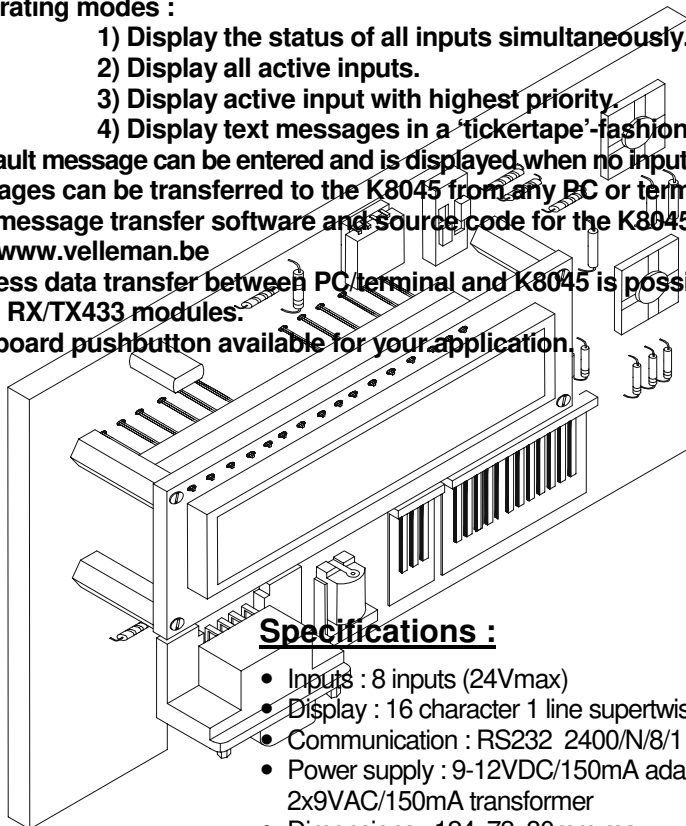

### Specifications :

- Inputs : 8 inputs (24Vmax)
- Display : 16 character 1 line supertwist backlit LCD
- Communication : RS232 2400/N/8/1 no handshaking
- Power supply : 9-12VDC/150mA adapter or 2x9VAC/150mA transformer
- Dimensions : 124x73x30mm max.

Modifications reserved

## 1. Assembly (Skipping this can lead to troubles !)

Ok, so we have your attention. These hints will help you to make this project successful. Read them carefully.

### 1.1 Make sure you have the right tools:

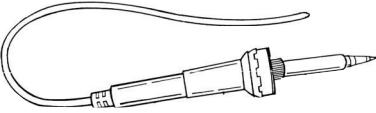
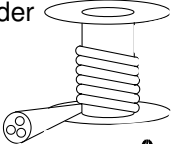
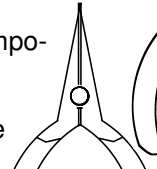
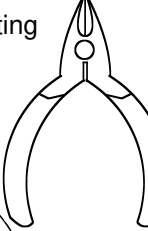
- A good quality soldering iron (25-40W) with a small tip. 
- Wipe it often on a wet sponge or cloth, to keep it clean; then apply solder to the tip, to give it a wet look. This is called 'thinning' and will protect the tip, and enables you to make good connections. When solder rolls off the tip, it needs cleaning. 
- Thin raisin-core solder. Do not use any flux or grease.
- A diagonal cutter to trim excess wires. To avoid injury when cutting excess leads, hold the lead so they cannot fly towards the eyes.
- Needle nose pliers, for bending leads, or to hold components in place. 
- Small blade and phillips screwdrivers. A basic range is fine. 



**For some projects, a basic multi-meter is required, or might be handy**

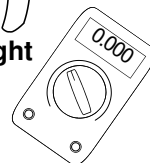

### 1.2 Assembly Hints :

- ⇒ Make sure the skill level matches your experience, to avoid disappointments.
- ⇒ Follow the instructions carefully. Read and understand the entire step before you perform each operation.
- ⇒ Perform the assembly in the correct order as stated in this manual
- ⇒ Position all parts on the PCB (Printed Circuit Board) as shown on the drawings.
- ⇒ Values on the circuit diagram are subject to changes.
- ⇒ Values in this assembly guide are correct\*
- ⇒ Use the check-boxes to mark your progress.
- ⇒ Please read the included information on safety and customer service

\* Typographical inaccuracies excluded. Always look for possible last minute manual updates, indicated as 'NOTE' on a separate leaflet.

**1.3 Soldering Hints :**

**1-** Mount the component against the PCB surface and carefully solder the leads

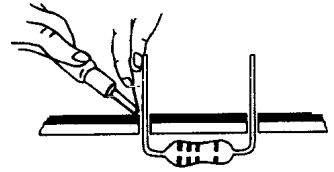

**2-** Make sure the solder joints are cone-shaped and shiny

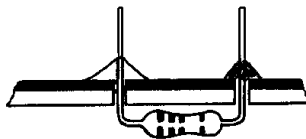
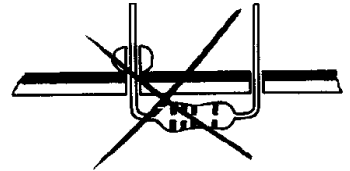

**3-** Trim excess leads as close as possible to the solder joint

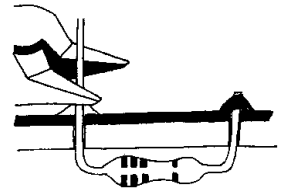

**AXIAL COMPONENTS ARE TAPED IN THE CORRECT MOUNTING SEQUENCE !**

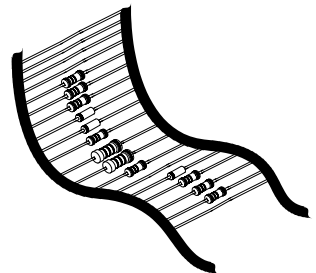

REMOVE THEM FROM THE TAPE ONE AT A TIME !

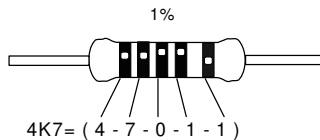
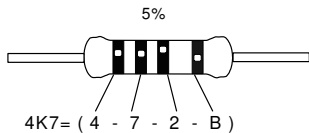

	I	P	E	SF	S	DK	N	D	GB	F	NL	
C O D E	CODICE	CODIGO	CODIGO	VÄRI	FÄRG	FARVE-	FARGE-	FARB	COLOUR	CODIFI-	KLEUR	C O D E
	COLORE	DE	DE COL-	KOODI	SCHEMA	KODE	KODE	KODE	CODE	CATION	KODE	
		CORES	ORES							DES		
										COU-		
										LEURS		
0	Nero	Preto	Negro	Musta	Svart	Sort	Sort	Schwarz	Black	Noir	Zwart	0
1	Marrone	Castanho	Marrón	Ruskea	Brun	Brun	Brun	Braun	Brown	Brun	Bruin	1
2	Rosso	Encarnado	Rojo	Punainen	Röd	Rød	Rød	Rot	Red	Rouge	Rood	2
3	Aran- ciato	Laranja	Naran- jado	Oranssi	Orange	Orange	Orange	Orange	Orange	Orange	Oranje	3
4	Giallo	Amarelo	Amarillo	Keltainen	Gul	Gul	Gul	Gelb	Yellow	Jaune	Geel	4
5	Verde	Verde	Verde	Vihreä	Grön	Grøn	Grønn	Grün	Green	Vert	Groen	5
6	Blu	Azul	Azul	Sininen	Blå	Blå	Blå	Blau	Blue	Bleu	Blauw	6
7	Viola	Violeta	Morado	Purppura	Lila	Violet	Violet	Violet	Purple	Violet	Paars	7
8	Grigio	Cinzeno	Gris	Harmaa	Grå	Grå	Grå	Grau	Grey	Gris	Grijs	8
9	Bianco	Branco	Blanco	Valkoinen	Vit	Hvid	Hvidt	Weiss	White	Blanc	Wit	9
A	Argento	Prateado	Plata	Hopea	Silver	Sølv	Sølv	Silber	Silver	Argent	Zilver	A
B	Oro	Dourado	Oro	Kulta	Guld	Guld	Guldl	Gold	Gold	Or	Goud	B

### 1. Jumperwire

- J1
- J2
- J3

### 2. Diodes (Check the polarity)

- D1 : 1N4007
- D2 : 1N4007
- D3 : 1N4148
- D4 : 1N4148
- D5 : 1N4148
- D6 : 1N4148
- D7 : 1N4148
- D8 : 1N4148
- D9 : 1N4148
- D10 : 1N4148

### 3. Zenerdiodes (Check the polarity)

- ZD1 : 5v1

### 4. Resistor

- R1 : 10K (1 - 0 - 3 - B)
- R2 : 10K (1 - 0 - 3 - B)
- R3 : 10K (1 - 0 - 3 - B)
- R4 : 100K (1 - 0 - 4 - B)
- R5 : 1K (1 - 0 - 2 - B)
- R7 : 1K (1 - 0 - 2 - B)
- R8 : 1K (1 - 0 - 2 - B)

- R10 : 1K (1 - 0 - 2 - B)
- R11 : 1K (1 - 0 - 2 - B)
- R13 : 1K (1 - 0 - 2 - B)
- R14 : 1K (1 - 0 - 2 - B)
- R16 : 1K (1 - 0 - 2 - B)
- R17 : 1K (1 - 0 - 2 - B)
- R19 : 1K (1 - 0 - 2 - B)
- R20 : 1K (1 - 0 - 2 - B)
- R22 : 1K (1 - 0 - 2 - B)
- R23 : 1K (1 - 0 - 2 - B)
- R25 : 1K (1 - 0 - 2 - B)
- R26 : 1K (1 - 0 - 2 - B)
- R28 : 1K (1 - 0 - 2 - B)
- R29 : 1K (1 - 0 - 2 - B)
- R30 : 22E0 (2 - 2 - 0 - B)
- R31 : 10K (1 - 0 - 3 - B)

### 5. Capacitors

- C2 : 100nF (104)
- C3 : 100nF (104)
- C4 : 100nF (104)
- C5 : 100nF (104)
- C7 : 15pF (15)
- C8 : 15pF (15)

### 6. IC socket (Watch the position of the notch)

- IC1 : 28p
- IC2 : 8p

**7. Push buttons**

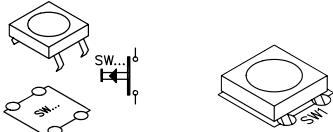

- SW2
- SW3

**8. DIP switch**

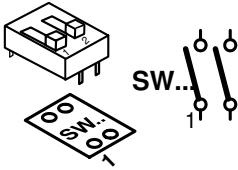

- SW1 : DIP-2

**9. Voltage regulator**

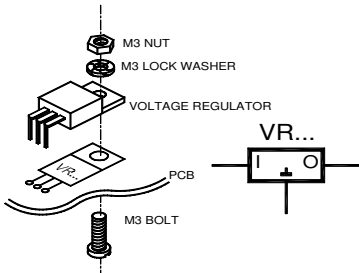

- VR1 : UA7805

**10. Connector**

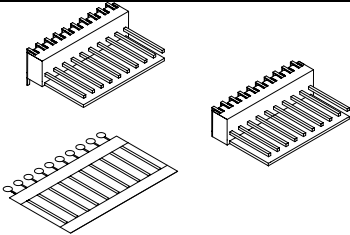

- SK1 : 3p
- SK8 : 12p

**11. Trim potentiometer**

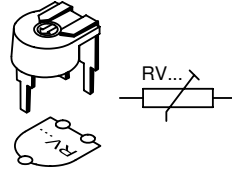

- RV1 : 10K

**12. 1/4W Resistors (check the color code)**

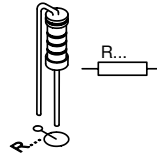

- R6 : 1K (1 - 0 - 2 - B)
- R9 : 1K (1 - 0 - 2 - B)
- R12 : 1K (1 - 0 - 2 - B)
- R15 : 1K (1 - 0 - 2 - B)
- R18 : 1K (1 - 0 - 2 - B)
- R21 : 1K (1 - 0 - 2 - B)
- R24 : 1K (1 - 0 - 2 - B)
- R27 : 1K (1 - 0 - 2 - B)

**13. Transistors**

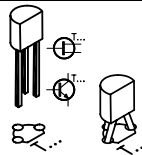

- T1 : BC557
- T2 : BC557
- T3 : BC557
- T4 : BC557
- T5 : BC557
- T6 : BC557
- T7 : BC557
- T8 : BC557

**14. Header**

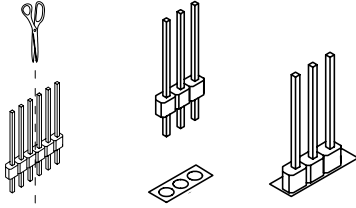

SK3 : 3p

**15. DC-jack**

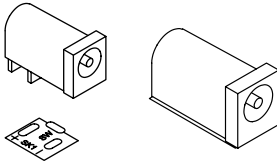

SK2

**16. SUB-D connector**

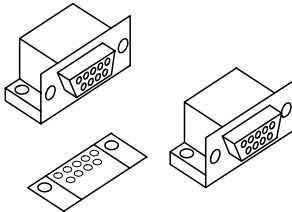

SK5 : SUB-D 9p female

**17. Electrolytic capacitors**

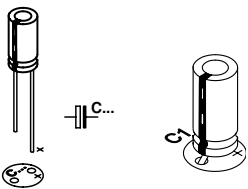

C6 : 10 $\mu$ F  
 C1 : 220 $\mu$ F/35V

**18. Quartz crystal**

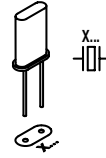

X1 : 4MHZ

**19. IC's**

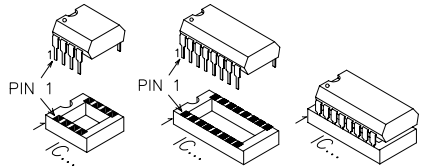

IC1 : VK8045 (PIC16C57)  
 IC2 : 24C02A

**20. Shunt selection**

RS232 cable operation

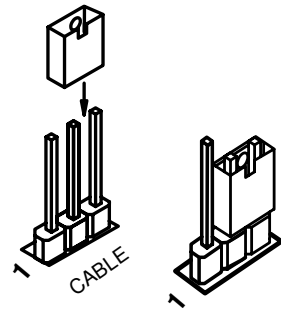

Wireless link

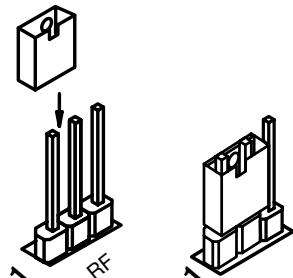

## 21. LCD assembling

- ❑ Cut the 20 pole connector to a 16 pole connector.

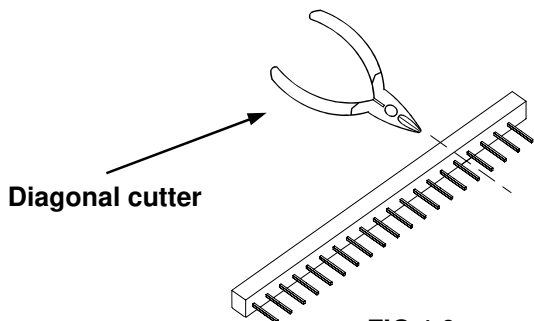

FIG.1.0

- ❑ Mount the 16 pole female connector. (see fig. 2.0)

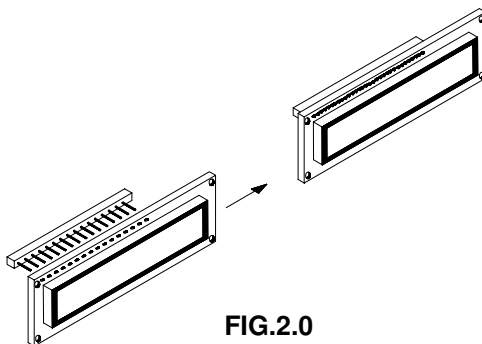

FIG.2.0

- ❑ Mount 2x 6 pole male connectors.  
**Pay attention** : The four center connections of the LCD remain unused.  
 Make sure that the longest pins aim towards the main PCB. (See Fig. 3.0)

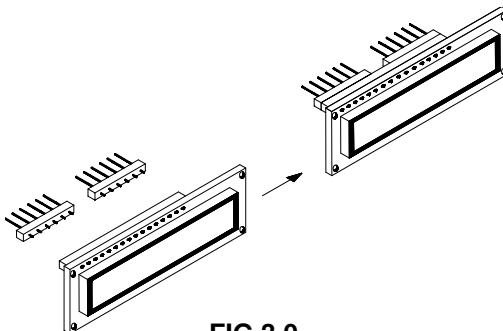
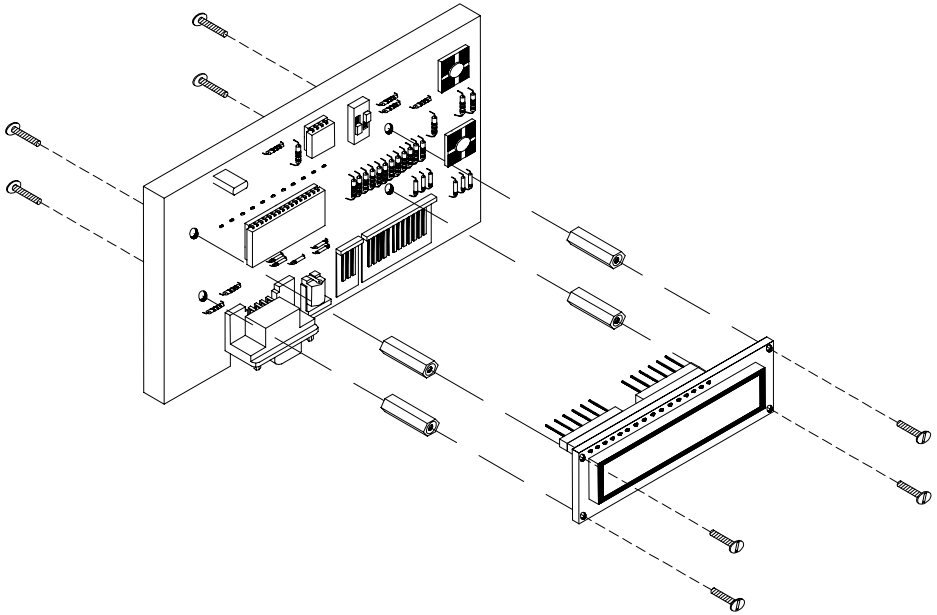

FIG.3.0



## 22. Assembly

Fit the display at the component side of the base PCB using four M2,5 bolts together with four 15mm spacers. Fix the display using four M2,5 bolts at the solder side of the base PCB and check that the display is at right angles to the base PCB.



Now you can solder the pinheader.

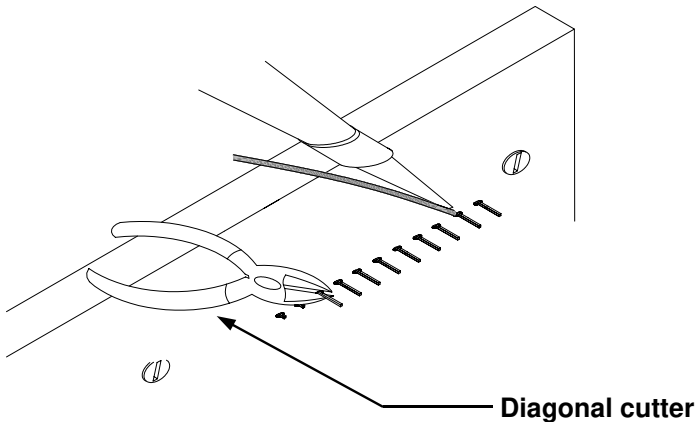

## 23. Connection

### 1. Hook-up when using an adapter :

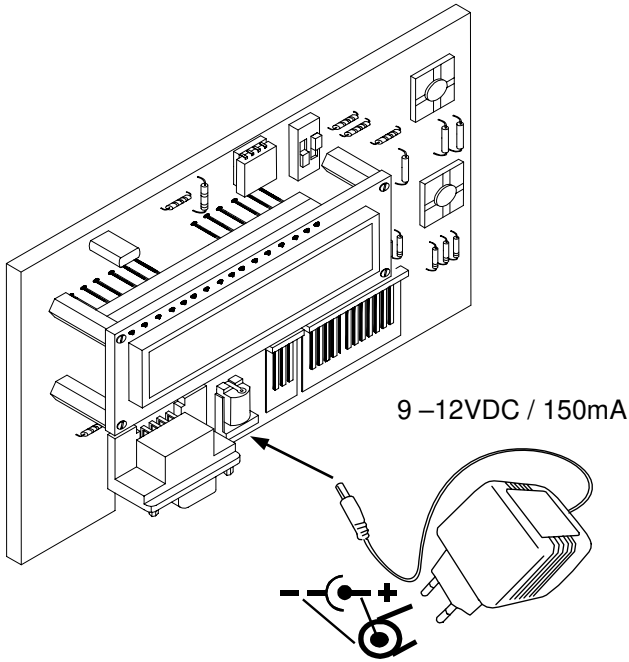

### 2. Hook-up when using a transformer

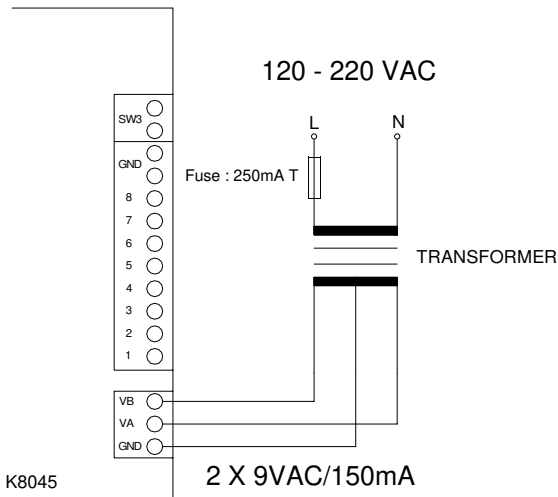

**24. Control options**

**How to construct an RS232 cable :**

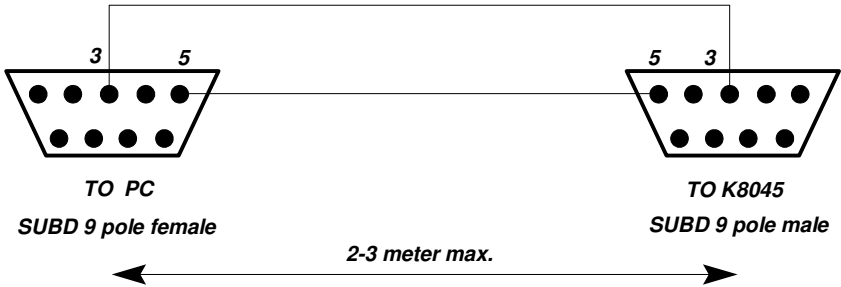

Or you can buy a pre-assembled cable. Careful : this is not a null-modem cable

**How to establish a wireless link :**

Wireless data transfer between the PC/terminal and the K8045 is possible by means of optional RF transmitter/receiver modules (Velleman part# TX433/RX433). Transmission quality depends on your environment. Other RF sources might interfere with your signal (and will cause occasional 'garbage' on-screen).

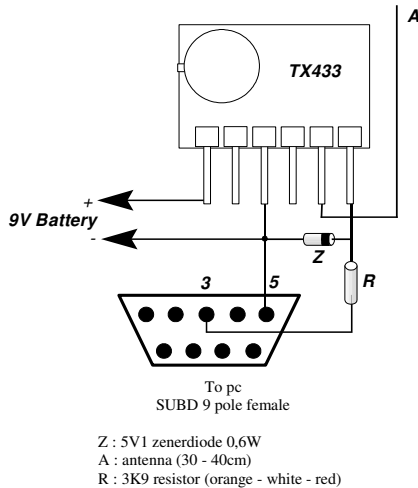

The receiver is mounted on the left hand side of the K8045 board. Watch the position, the coils point to the LCD of the K8045. If you choose wireless operation, make sure to set jumper SK3 to 'RF'

## 25. Testing

- Turn RV1 (contrast) fully anti-clockwise.
- Set dipswitches SW1 (mode) to the 'off'-position.
- Set jumper SK3 for 'cable'-operation but do not connect a serial cable
- Connect the supplied wired female connector to SK8
- Apply power (for power requirements, see pag. 10)

The LCD should initialise and the following text should appear :

K8045 Vxxxxxxx ('x' indicates software version)

If the message 'EEPROM FAILURE' appears, check the position of IC2 and/or re-check the complete assembly

Next, the display will show : 1 2 3 4 5 6 7 8

Check input 1 by shorting the left hand brown and the black wire. An 'x' appears next to the '1' on the screen, indicating 'input active'

Check all inputs (brown to grey) in a similar fashion.

- Next, flip dipswitch 2 of SW1 to the 'ON' position.

The display should display '9' (the ninth message is displayed when no inputs are active). Repeat the input test as above, but now the display will show the active input only

### **RS232 interface setup :**

Hook-up a serial cable (for details, see pag. 11) between a free serial port of your computer/terminal and the K8045. You can download free software from our website [www.velleman.be](http://www.velleman.be), which allows you to transfer messages from the PC to your K8045 and which allows you to display messages on you K8045. You can also use a terminal or terminal emulation program to manually enter messages. Terminal settings are :

**Baudrate** : 2400

**Parity** : none

**Databits** : 8

**Stopbits** : 1

**No handshaking**

**26. Entering messages with a terminal program :**

The K8045 can store 9 sixteen-character messages, 1 for each input and a 9th which is displayed when no inputs are active.

Briefly press SW2 'PROG' to enter program mode  
The display shows 'INPUT 1..9 / S / Q : ' and a flashing cursor

To enter a message for input 1 :  
Type '1' 'ENTER'

The unit now displays 'TRIGGER (1/0):' and a flashing cursor

If you want the message to appear when the input is active (grounded), type '0' 'ENTER'  
In case you want the message to appear when the input is not active (left open), Type '1' 'ENTER'  
(If you do not want to change the settings for this input, press 'BACKSPACE' to return to the previous menu)

The display now show the current message for this input.  
If you do not wish to change the message for this input, press 'BACKSPACE' to return to the input selection menu

If you wish to change the current message, simply type a new message and press 'ENTER'

Your message is now stored and the unit returns to the input selection menu

You can now enter messages for all inputs (1..9).  
Message 9 is displayed when no input is active and does not allow you to enter a trigger setting.

To exit programming mode, type 'Q' (capital).

(Note : You can download software from our website [www.velleman.be](http://www.velleman.be) which makes it very easy to store, edit and transfer messages, without the need for a terminal program)

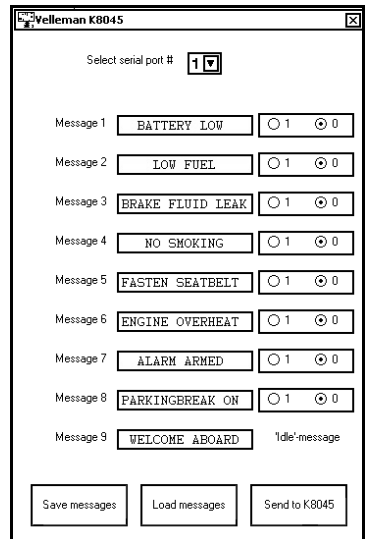

## 27. Operating modes :

The K8045 features 4 operating modes, selectable with dipswitch SW1.  
To ensure correct operation, disconnect power before changing dipswitch position.  
(Program mode can be selected at all times, no need to disconnect power)

- 1) Display the status of all inputs simultaneously
- 2) Display all active inputs
- 3) Display active input with highest priority
- 4) Display text messages in a 'tickertape'-fashion

MODE	DIPSWITCH SW1	
	1	2
1	OFF	OFF
2	OFF	ON
3	ON	OFF
4	ON	ON

### 1) Display the status of all inputs simultaneously :

All inputs are displayed. An 'x' appears on the right hand side of an active (grounded) input.

### 2) Display all active inputs :

For every active input, a corresponding message is displayed. There is a delay between each message, to allow the user to read the message. Message 9 is displayed when no inputs are active.

### 3) Display active input with highest priority :

Message 1 has highest priority, message 8 has lowest priority.  
Only one message will be displayed. Message 9 is displayed when no inputs are active.

### 4) Display text messages in a 'tickertape'-fashion :

This mode allows you to send messages to the K8045 from a remote location by either RS232 cable or optional wireless link (see page 11) and display them on-screen. If the message exceeds 16 characters, the message scrolls to the left.

An ID# can be assigned to the K8045 ranging from 0 to 9 (default : 0). This allows you to determine which K8045 will receive and display the message, which is handy for wireless link applications. In this way, up to ten K8045 units can be individually addressed.

You can download a small program from our website [www.velleman.be](http://www.velleman.be) which allows you to set the ID # and send messages in a simple fashion to your K8045. The source code is supplied, for users who would like to modify the code for their proper applications.

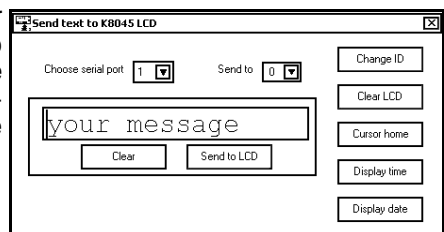

**28. Options & examples**

**Options :**

RF wireless link : ..... RX433/TX433

HQ supertwist LCD display : ..... LCD1601ASL

**Application examples :**

- 1. **Home alarm system : let your alarm system tell you what sensor has been triggered**

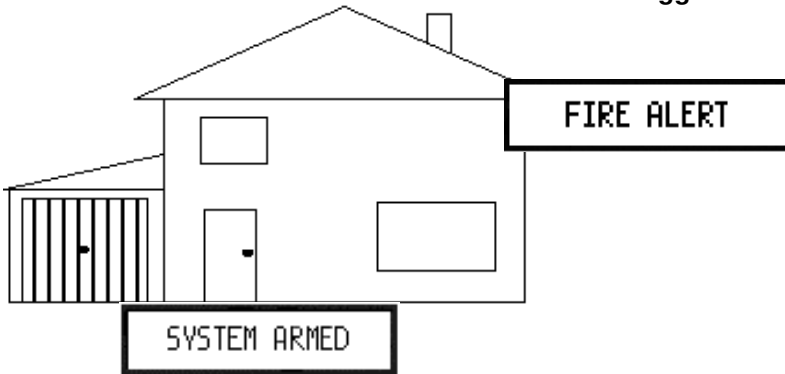

- 2. **Replace car indicator lamps**

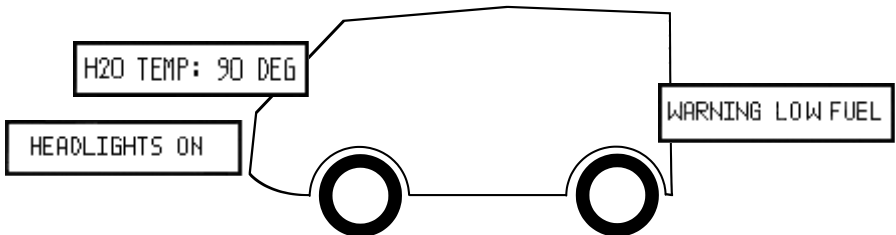

### 3. Application with K8023 “Two wire 10-channel remote control”

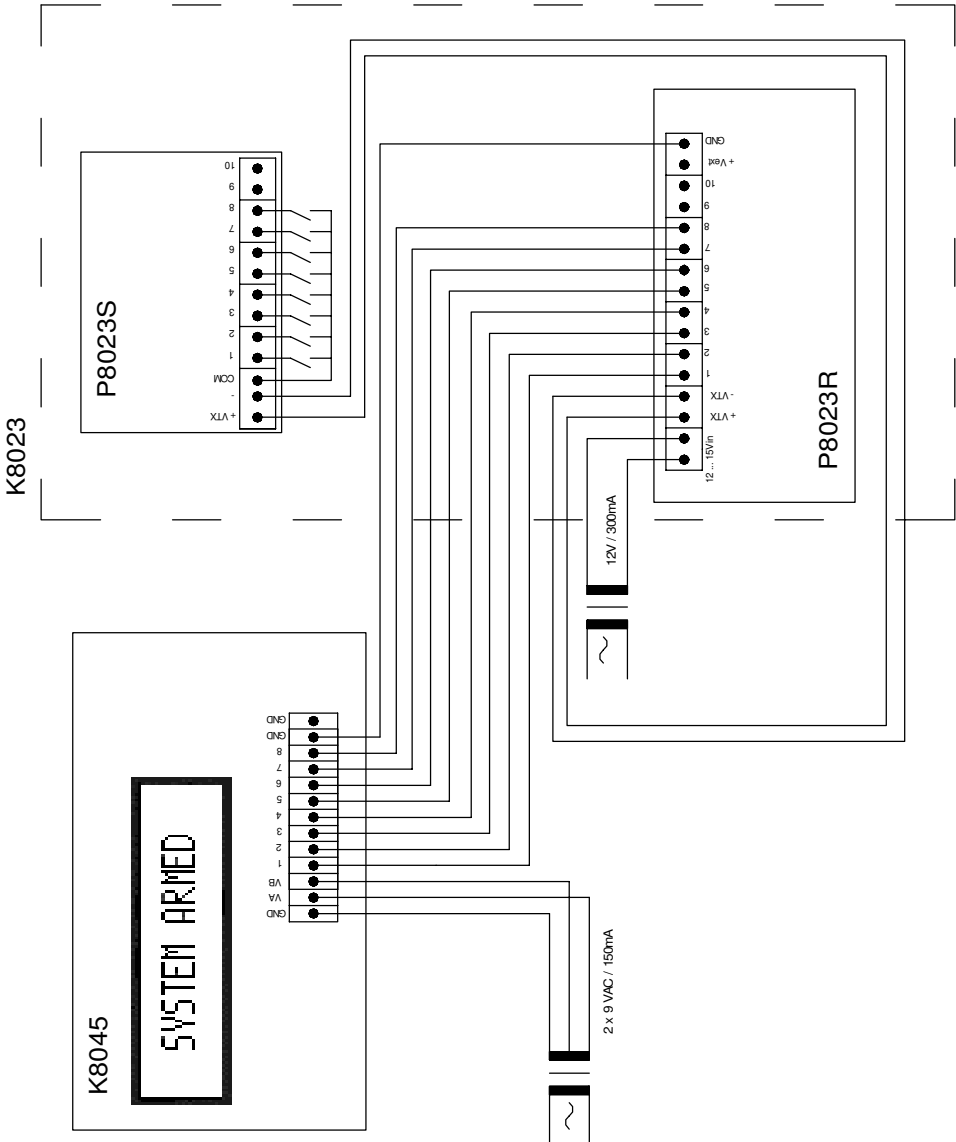



**PCB  
&  
DIAGRAMS**





**VELLEMAN COMPONENTS NV**  
**Legen Heirweg 33**  
**9890 Gavere**  
**Belgium Europe**  
**Info & support: [www.velleman.be](http://www.velleman.be)**

Modifications and typographical errors reserved  
© Velleman Components NV  
H80451P - 2002 - ED1