

4 channel running light

Features:

K8032

- Adjustable speed.
- Suited for inductive loads.
- 4 channels with LED indicator.
- Ideal for disco effects.
- Noise suppressed according to EN55015.

Specifications :

- AC Power : 110 to 240 VAC.
- Auto frequency detection : 50/60Hz.
- Max load per channel 2A : 200W (110 - 125VAC)
400W (220 - 240VAC)
- Adjustable speed : 0,2 to 3Hz.
- Dimensions : 100 x 82 x 35mm / 4 x 3,3 x 1,4"

Modifications reserved.

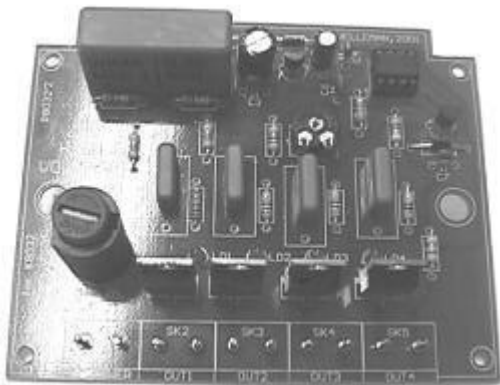



VELLEMAN Components NV
Legen Heirweg 33
9890 Gavere
Belgium Europe
www.velleman.be
www.velleman-kit.com

1. Assembly (Skipping this can lead to troubles !)

Ok, so we have your attention. These hints will help you to make this project successful. Read them carefully.

1.1 Make sure you have the right tools:

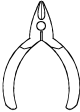
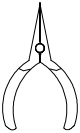
- A good quality soldering iron (25-40W) with a small tip. 
- Wipe it often on a wet sponge or cloth, to keep it clean; then apply solder to the tip, to give it a wet look. This is called 'thinning' and will protect the tip, and enables you to make good connections. When solder rolls off the tip, it needs cleaning.
- Thin rosin-core solder. Do not use any flux or grease. 
- A diagonal cutter to trim excess wires. To avoid injury when cutting excess leads, hold the lead so they cannot fly towards the eyes. 
- Needle nose pliers, for bending leads, or to hold components in place. 
- Small blade and Phillips screwdrivers. A basic range is fine.



For some projects, a basic multi-meter is required, or might be handy

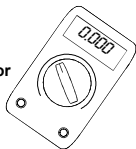

1.2 Assembly Hints :

- ⇒ Make sure the skill level matches your experience, to avoid disappointments.
- ⇒ Follow the instructions carefully. Read and understand the entire step before you perform each operation.
- ⇒ Perform the assembly in the correct order as stated in this manual
- ⇒ Position all parts on the PCB (Printed Circuit Board) as shown on the drawings.
- ⇒ Values on the circuit diagram are subject to changes.
- ⇒ Values in this assembly guide are correct*
- ⇒ Use the check-boxes to mark your progress.
- ⇒ Please read the included information on safety and customer service

* Typographical inaccuracies excluded. Always look for possible last minute manual updates, indicated as 'NOTE' on a separate leaflet.

1.3 Soldering Hints :

Mount the component against the PCB surface and carefully solder the leads

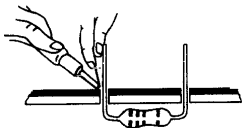

Make sure the solder joints are cone-shaped and shiny



Trim excess leads as close as possible to the solder joint

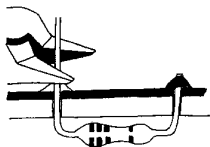

AXIAL COMPONENTS ARE TAPED IN THE CORRECT MOUNTING SEQUENCE !

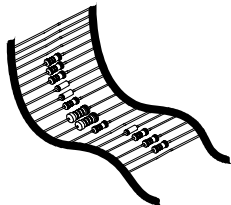

REMOVE THEM FROM THE TAPE ONE AT A TIME !

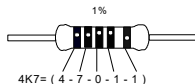
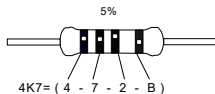

	I	P	E	SF	S	DK	N	D	GB	F	NL	
C O D E	CODICE COLORE	CODIGO DE CORES	CODIGO DE COL- ORES	VÄRI KOODI	FÄRG SCHEMA	FARVE- KODE	FARGE- KODE	FARB KODE	COLOUR CODE	CODIFI- CATION DES COU- LEURS	KLEUR KODE	C O D E
0	Nero	Preto	Negro	Musta	Svart	Sort	Sort	Schwarz	Black	Noir	Zwart	0
1	Marrone	Castanho	Marrón	Ruskea	Brun	Brun	Brun	Braun	Brown	Brun	Bruin	1
2	Rosso	Encarnado	Rojo	Punainen	Röd	Rød	Rød	Rot	Red	Rouge	Rood	2
3	Aranciato	Laranja	Naranjado	Oranssi	Orange	Orange	Orange	Orange	Orange	Orange	Oranje	3
4	Giallo	Amarelo	Amarillo	Keltainen	Gul	Gul	Gul	Gelb	Yellow	Jaune	Geel	4
5	Verde	Verde	Verde	Vihreä	Grön	Grøn	Grønn	Grün	Green	Vert	Groen	5
6	Blu	Azul	Azul	Sininen	Blå	Blå	Blå	Blau	Blue	Bleu	Blauw	6
7	Viola	Violeta	Morado	Purppura	Lila	Violet	Violet	Violet	Purple	Violet	Paars	7
8	Grigio	Cinzeno	Gris	Harmaa	Grå	Grå	Grå	Grau	Grey	Gris	Grijs	8
9	Bianco	Branco	Blanco	Valkoinen	Vit	Hvid	Hvidt	Weiss	White	Blanc	Wit	9
A	Argento	Prateado	Plata	Hopea	Silver	Sølv	Sølv	Silber	Silver	Argent	Zilver	A
B	Oro	Dourado	Oro	Kulta	Guld	Guld	Guldl	Gold	Gold	Or	Goud	B

1. 1/4W Resistors

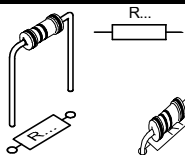

- R4: 3K3 (3-3-2-B)
- R6: 270 (2-7-1-B)
- R7: 270 (2-7-1-B)
- R8: 270 (2-7-1-B)
- R9: 270 (2-7-1-B)

2. 1/2W Resistors

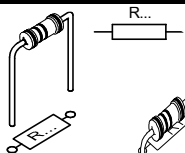

- R2: 220K (2-2-4-B-9)
- R3: 220K (2-2-4-B-9)
- R5: 470K (4-7-4-B-9)
- R10: 47 (4-7-0-B-9)
- R11: 47 (4-7-0-B-9)
- R12: 47 (4-7-0-B-9)
- R13: 47 (4-7-0-B-9)

3. Diodes

Watch the polarity !

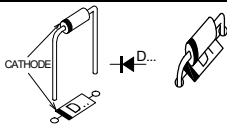

- D1 : 1N4007
- D2 : 1N4007

4. Zenerdiode

Watch the polarity !

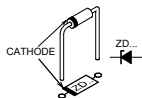

- ZD1 : ZB12V0

5. IC socket, Watch the position of the notch!

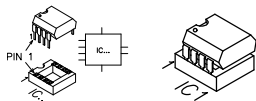

- IC1 : 8P

6. 1W Resistor

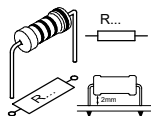

- R1 : 220 (2-2-1-B)

7. Capacitors



- C3 : 100n (104)
- C4 : 100n (104)
- C6 : 100p (101)
- C7 : 10n (103)

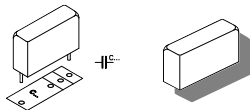

- C8 : 10nF / 600V
- C9 : 10nF / 600V
- C10 : 10nF / 600V
- C11 : 10nF / 600V

8. PCB tabs

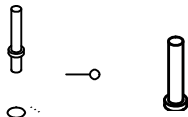

- SK1 : Power (2X)
- SK2 : Out1 (2X)
- SK3 : Out2 (2X)
- SK4 : Out3 (2X)
- SK5 : Out4 (2X)

9. Trim potentiometer

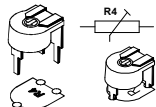

- RV1 : 100K

10. Transistors.

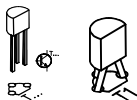

- T1 : BC547

11. Voltage Regulator



- VR1 : UA78L05

12. Electrolytic Capacitors.

Watch the polarity !

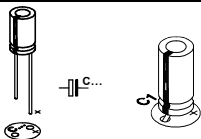

- C2 : 220 μ F / 25V
- C5 : 10 μ F / 35V

13. Fuseholder + Fuse

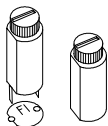

- F1 : 2A (slow)

14. Triac.

The back side corresponds to the thick line.



- TR1 : TIC225M
- TR2 : TIC225M
- TR3 : TIC225M
- TR4 : TIC225M

15. Capacitors

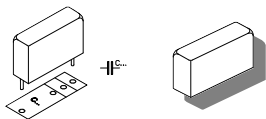

- C1 : 680n / 600V

16. LED's.

Watch the polarity !

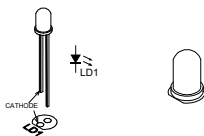

- LD1: 3mm Red
- LD2: 3mm Red
- LD3: 3mm Red
- LD4: 3mm Red

17. IC, Check the position of the notch !

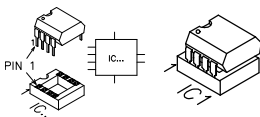

- IC1: PIC12C508A

18. Hook-up and use

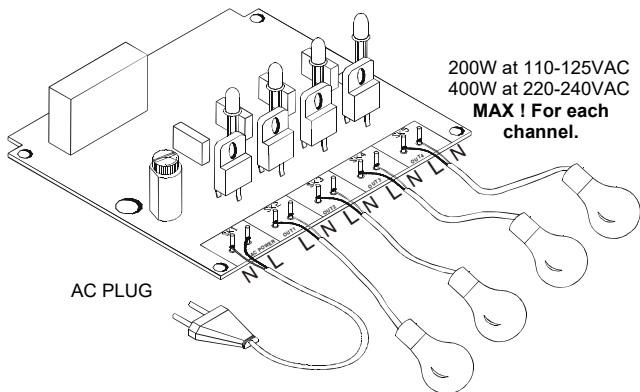

- Solder an AC cable to the SK1 pins (AC Power).
- Solder the cables of each lampholder to the appropriate pins.

As this kit is shipped to different countries, there is no AC plug supplied. You will need to attach a plug that matches your electrical system.

You can adjust the running speed by turning the trimmer "RV1". Each LED will light up when a channel is activated.

Inspect the complete assembly once more before applying power to the unit !

19. PCB layout.

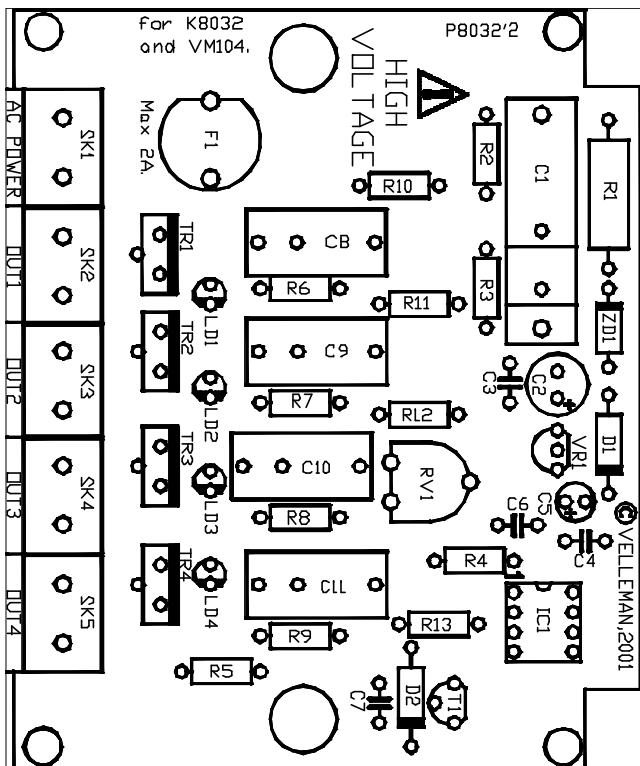

20. Schematic diagram.

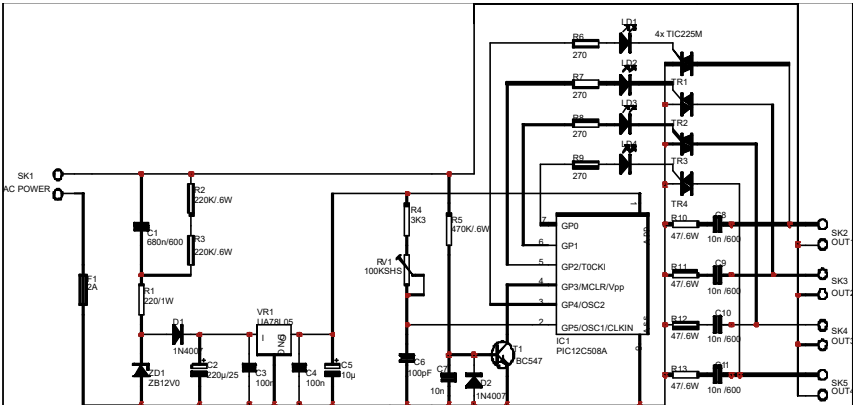

VELLEMAN Components NV
Legen Heirweg 33
9890 Gavere
Belgium Europe
www.velleman.be
www.velleman-kit.com

Modifications and typographical errors reserved
© Velleman Components nv.
H8032IP - 2002 - ED1